

The Sun

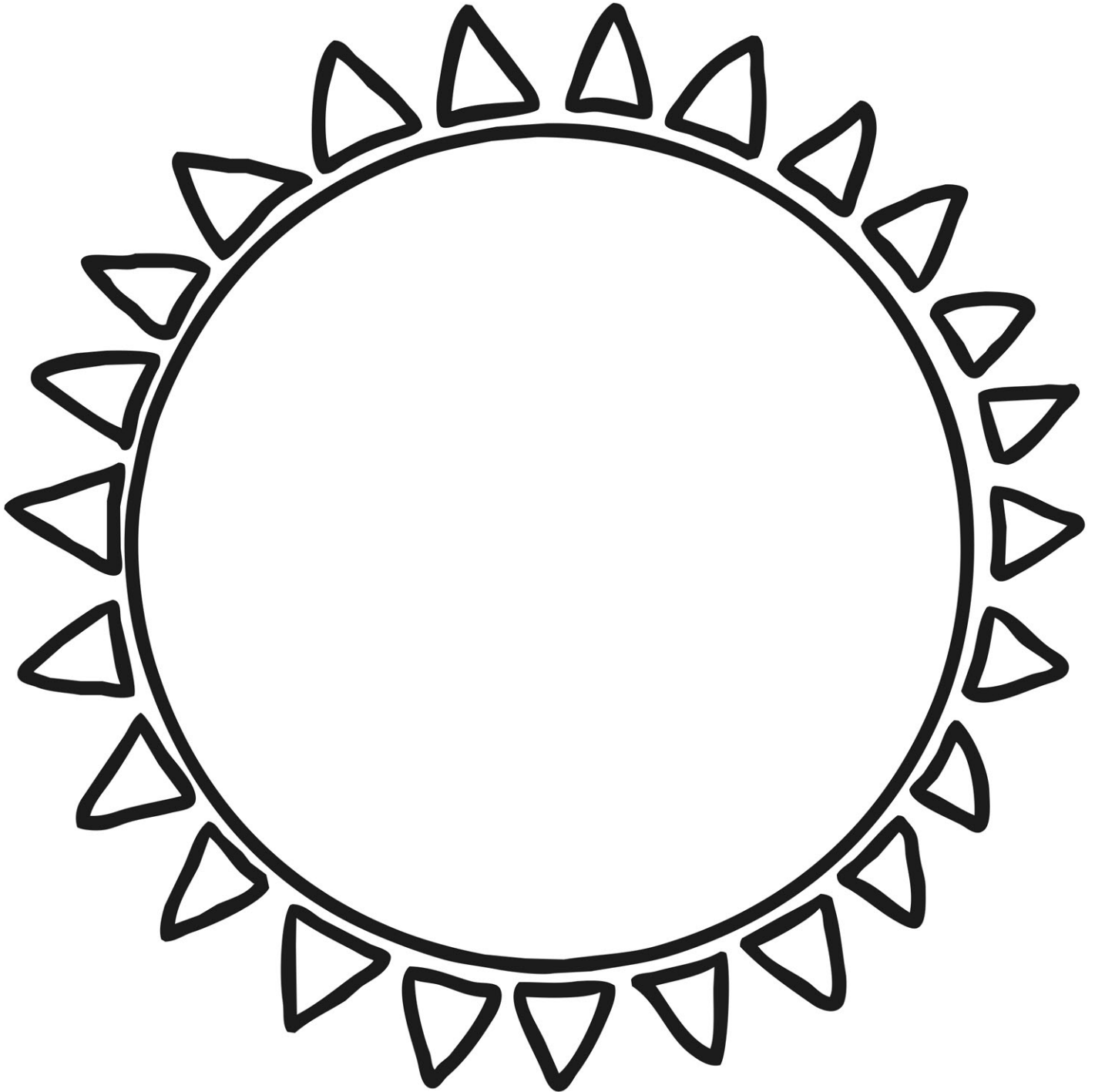

Star

● 1

● 10

● 2

9 ●

● 3

● 8

● 4

● 6

● 7

● 5



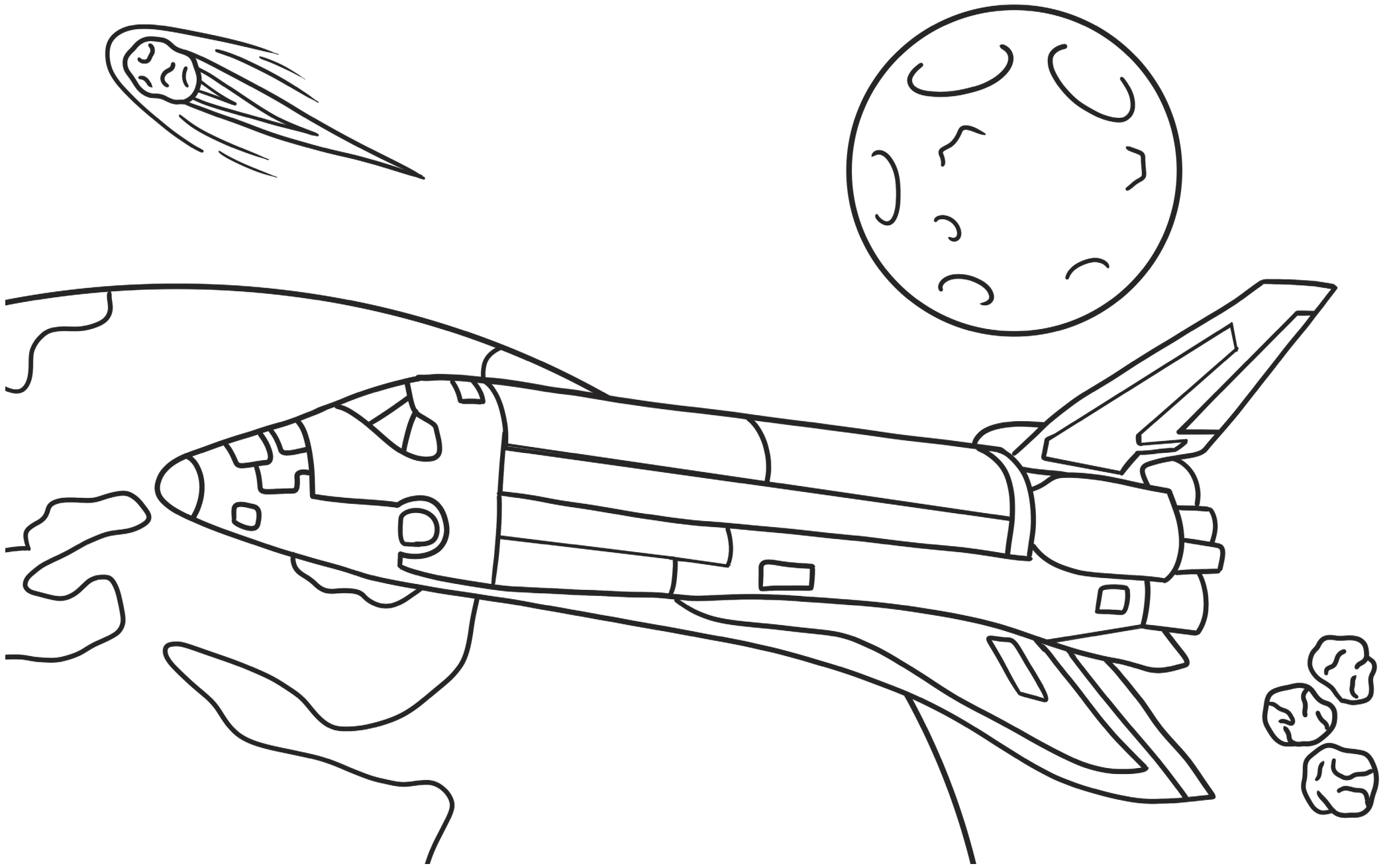



Who's in Space?

Have fun using tin foil to decorate this rocket.

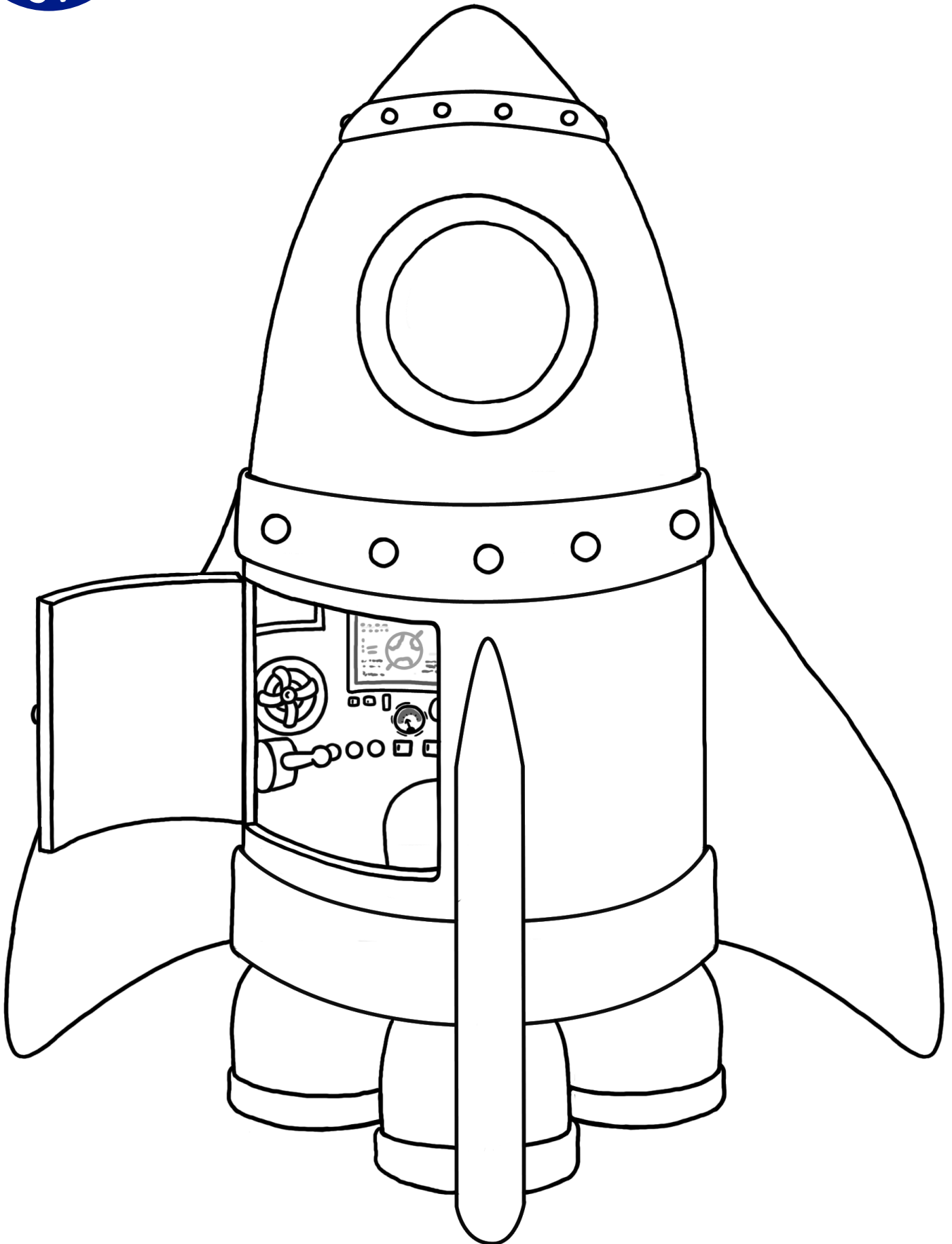

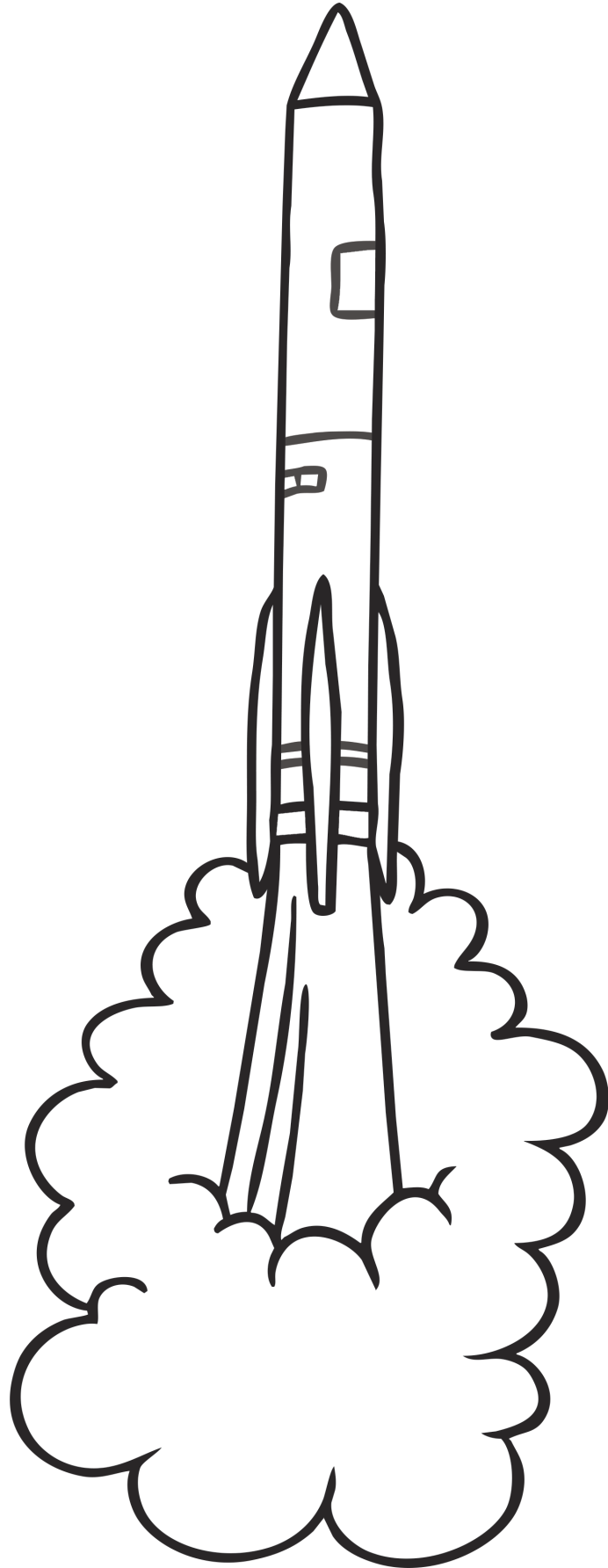

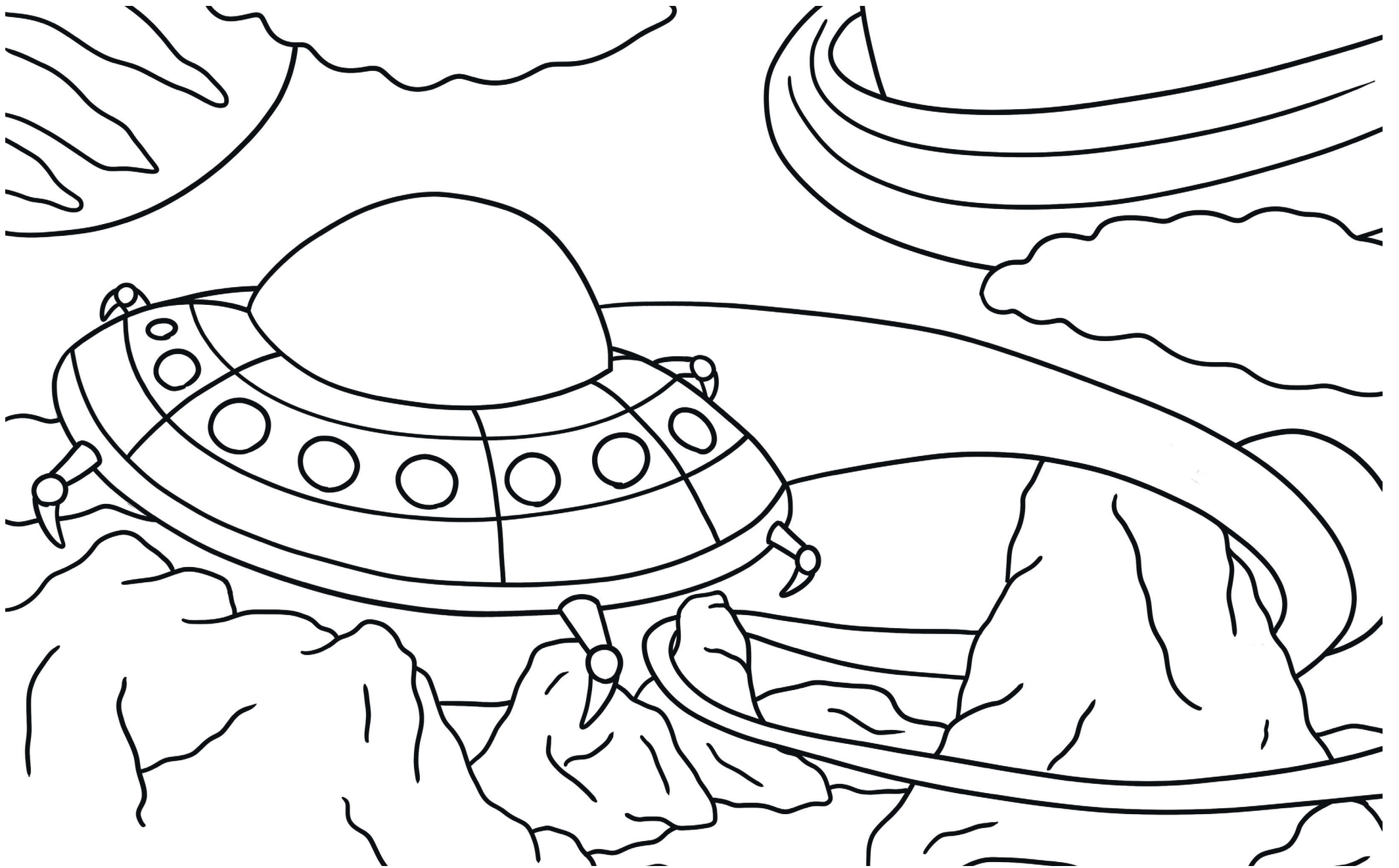

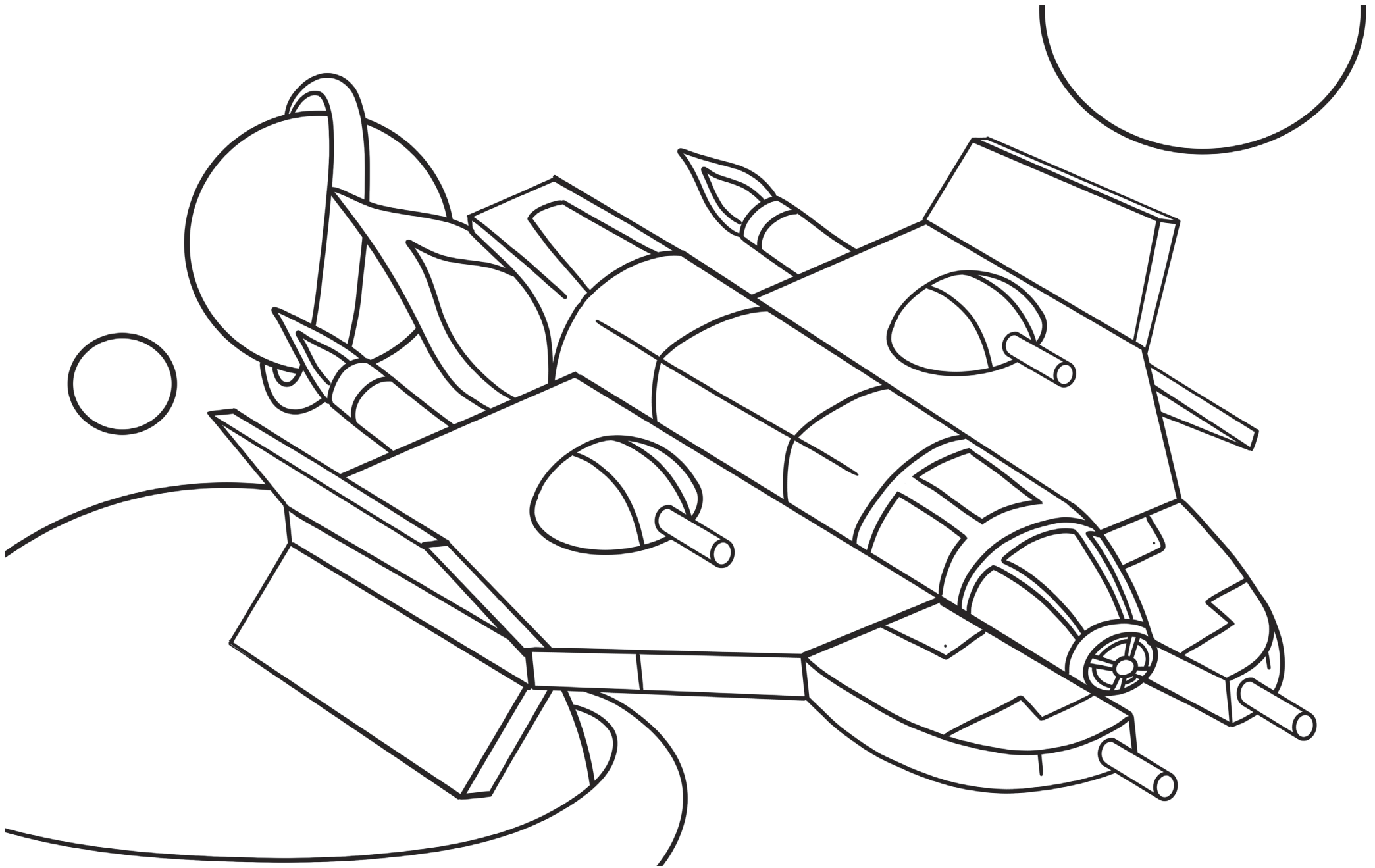

Planet

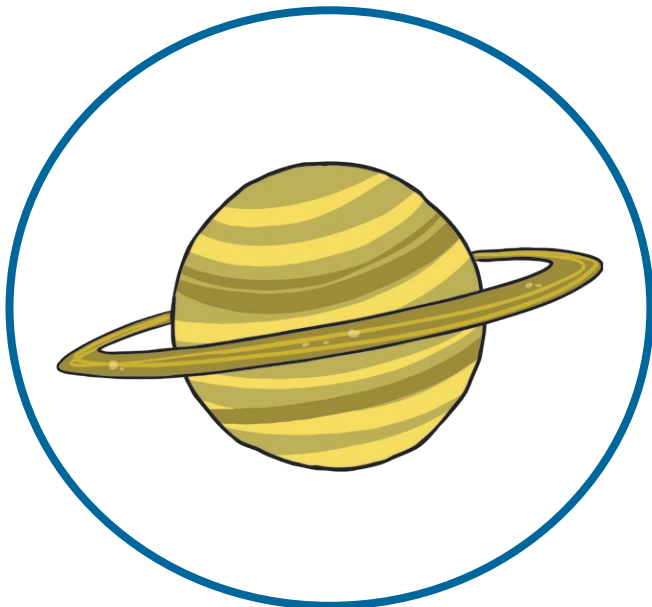
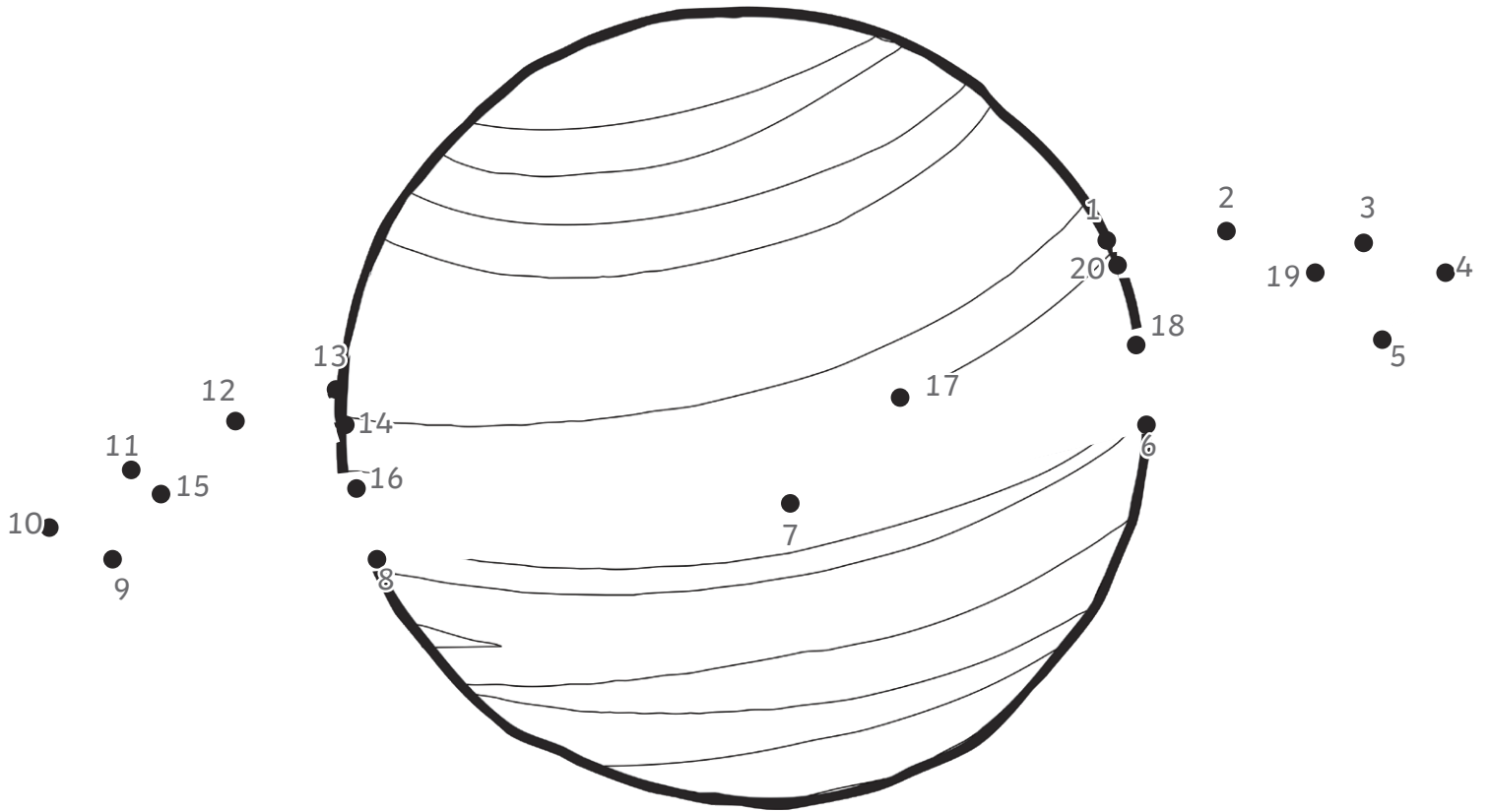

Space Shuttle

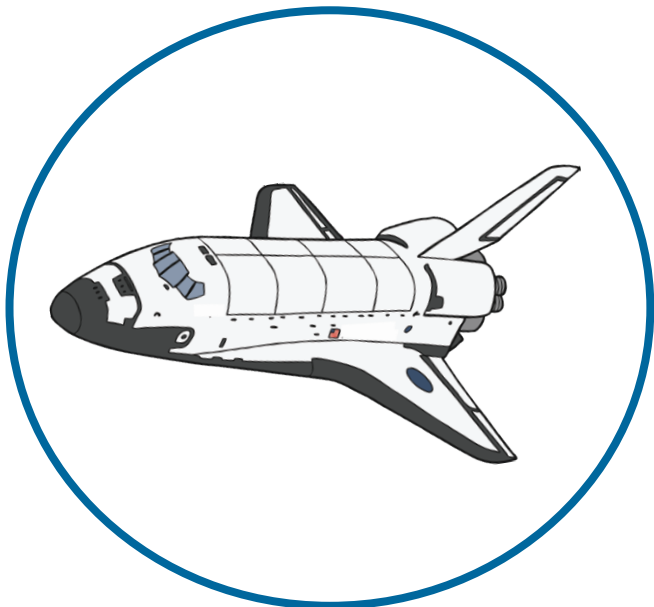
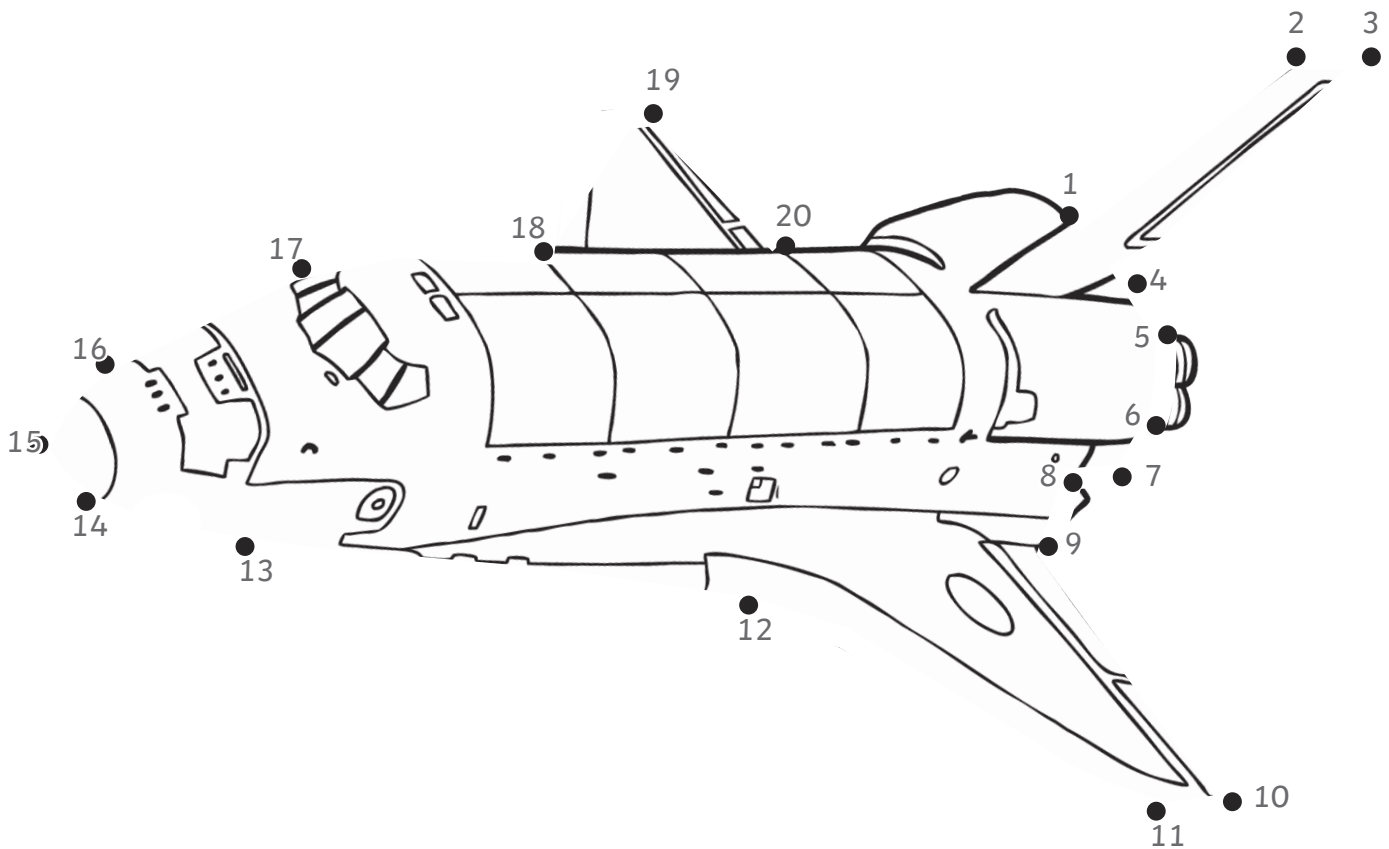

Astronaut

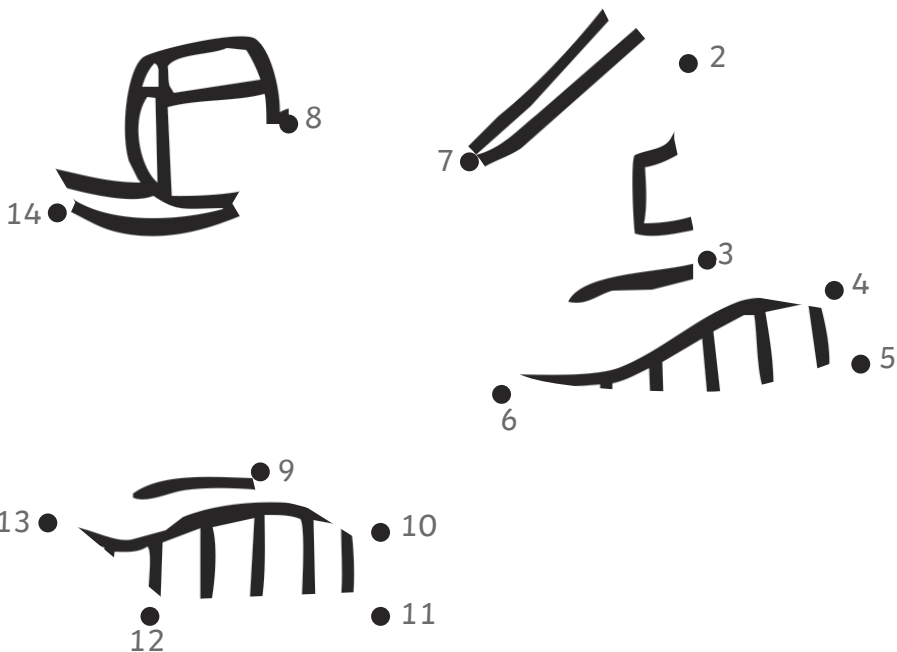
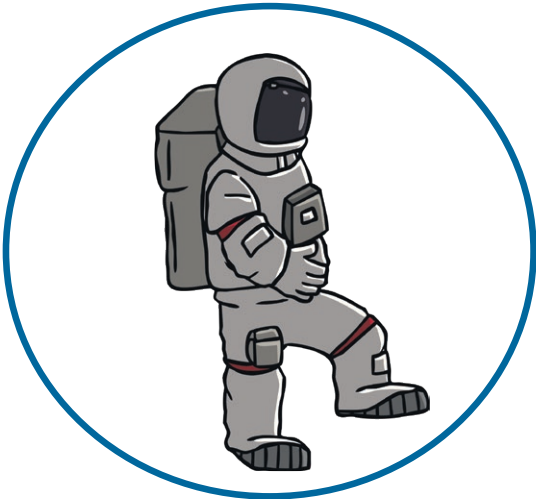
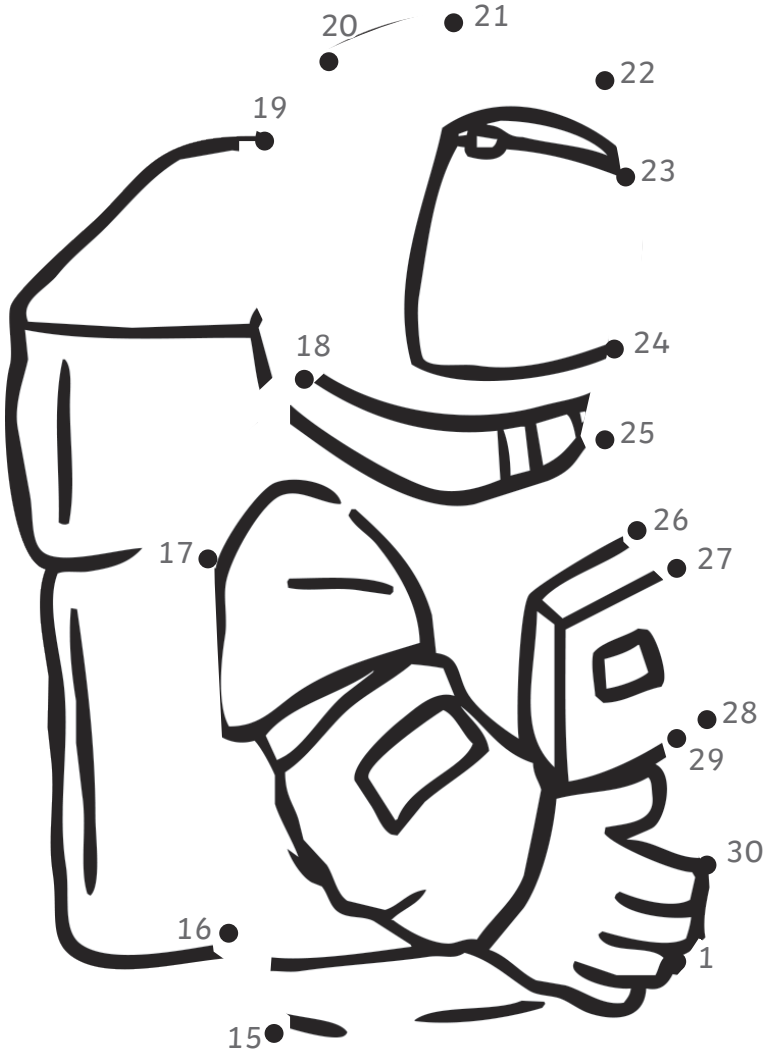

Rocket

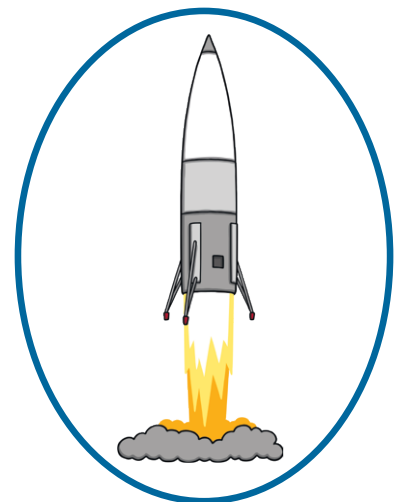
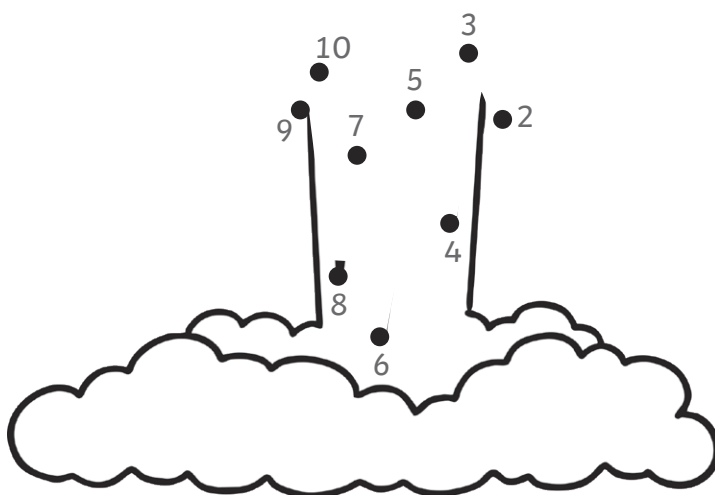
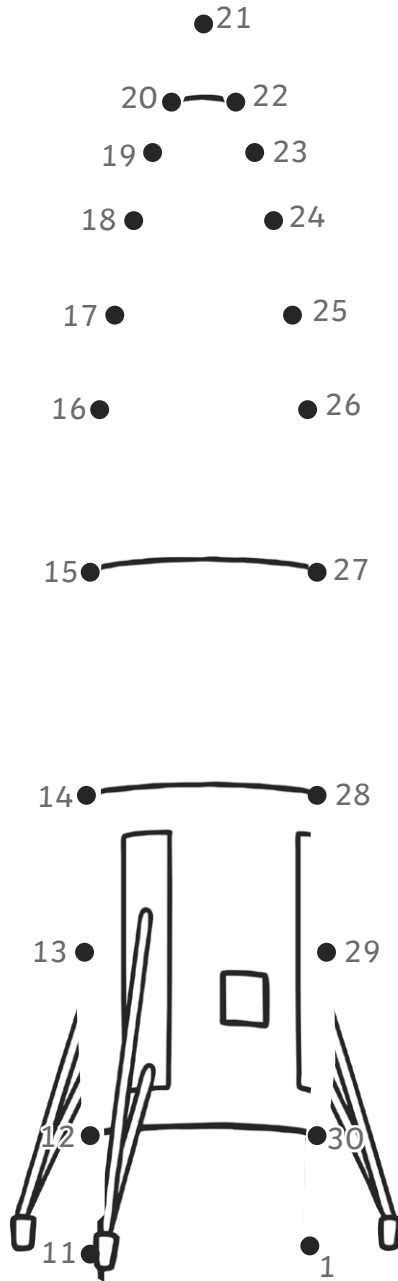

Roll, Add and Colour!

Work out the answers then colour them in!

-  1 = red
-  2 = dark blue
-  3 = dark green
-  4 = yellow
-  5 = pink
-  6 = purple
-  7 = orange
-  8 = brown
-  9 = light blue
-  10 = light green

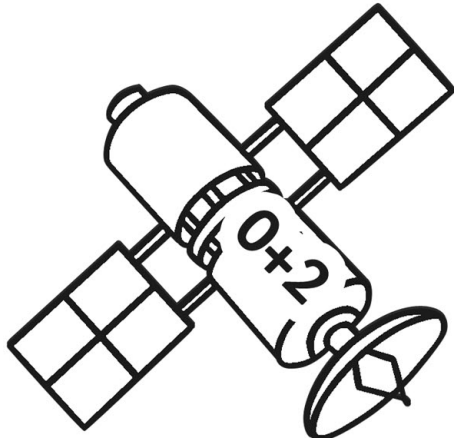
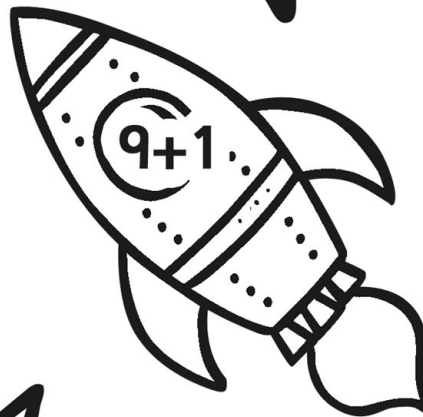
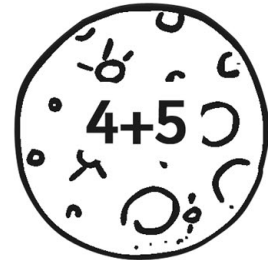
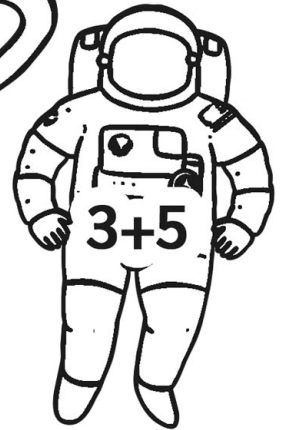
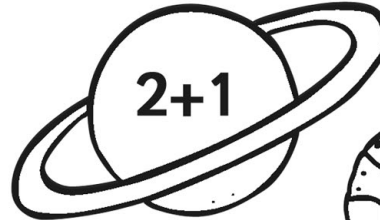
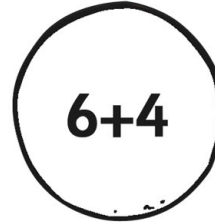
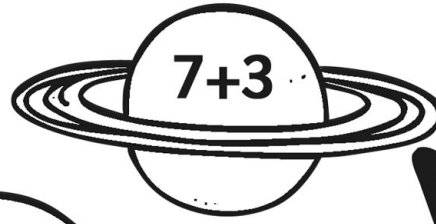

Alien



Stars

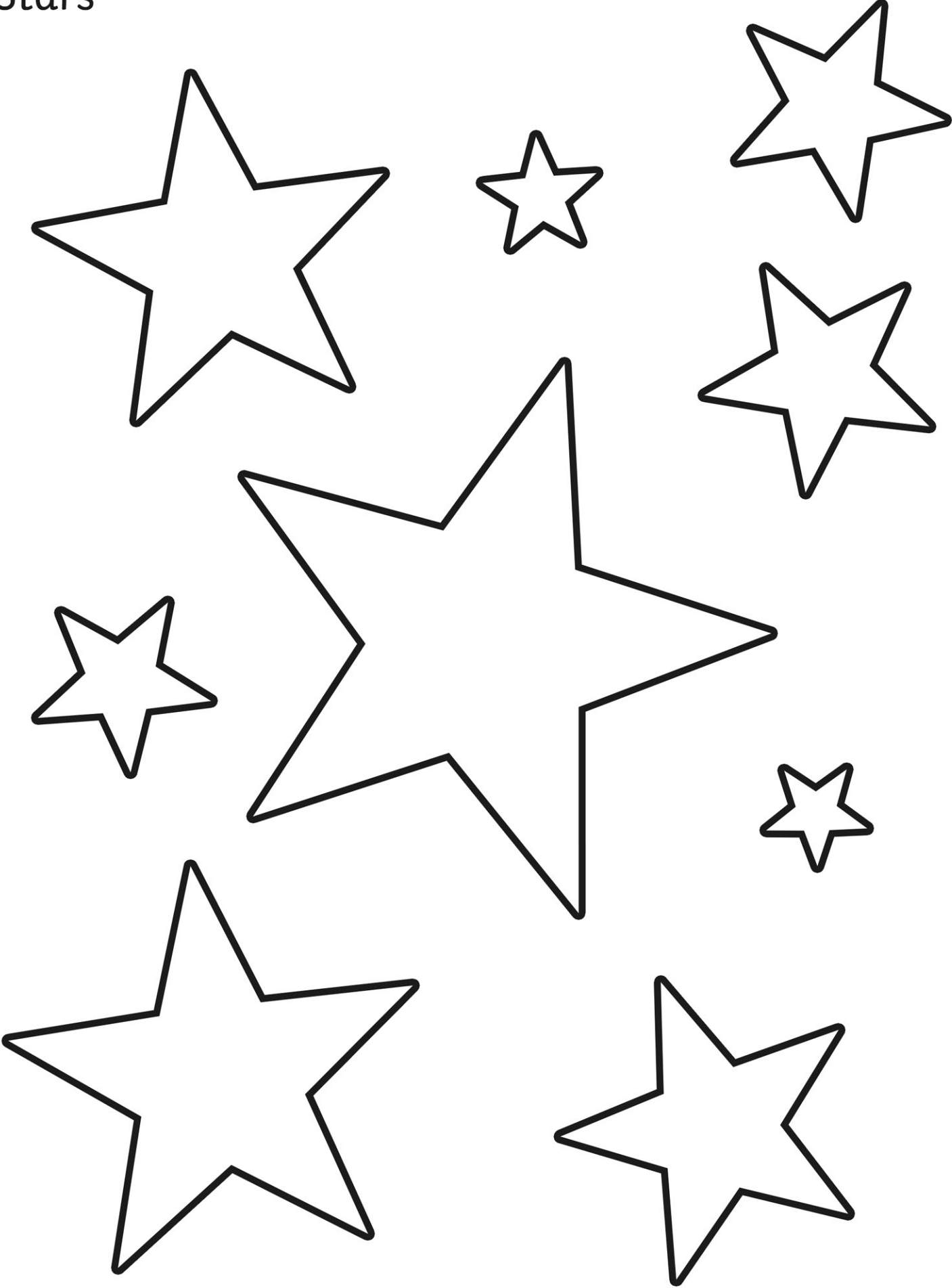

Earth



Moon

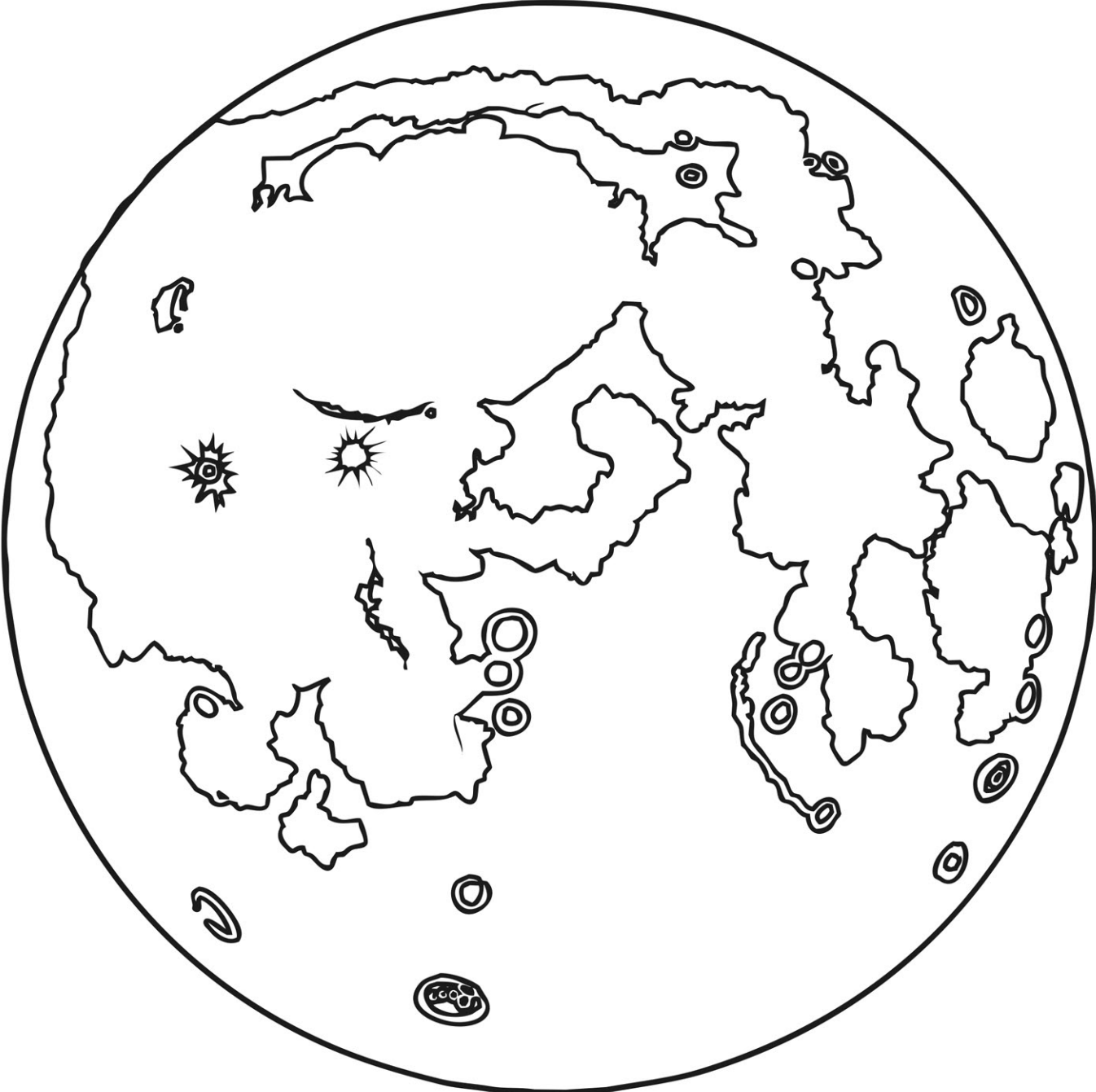

Astronaut

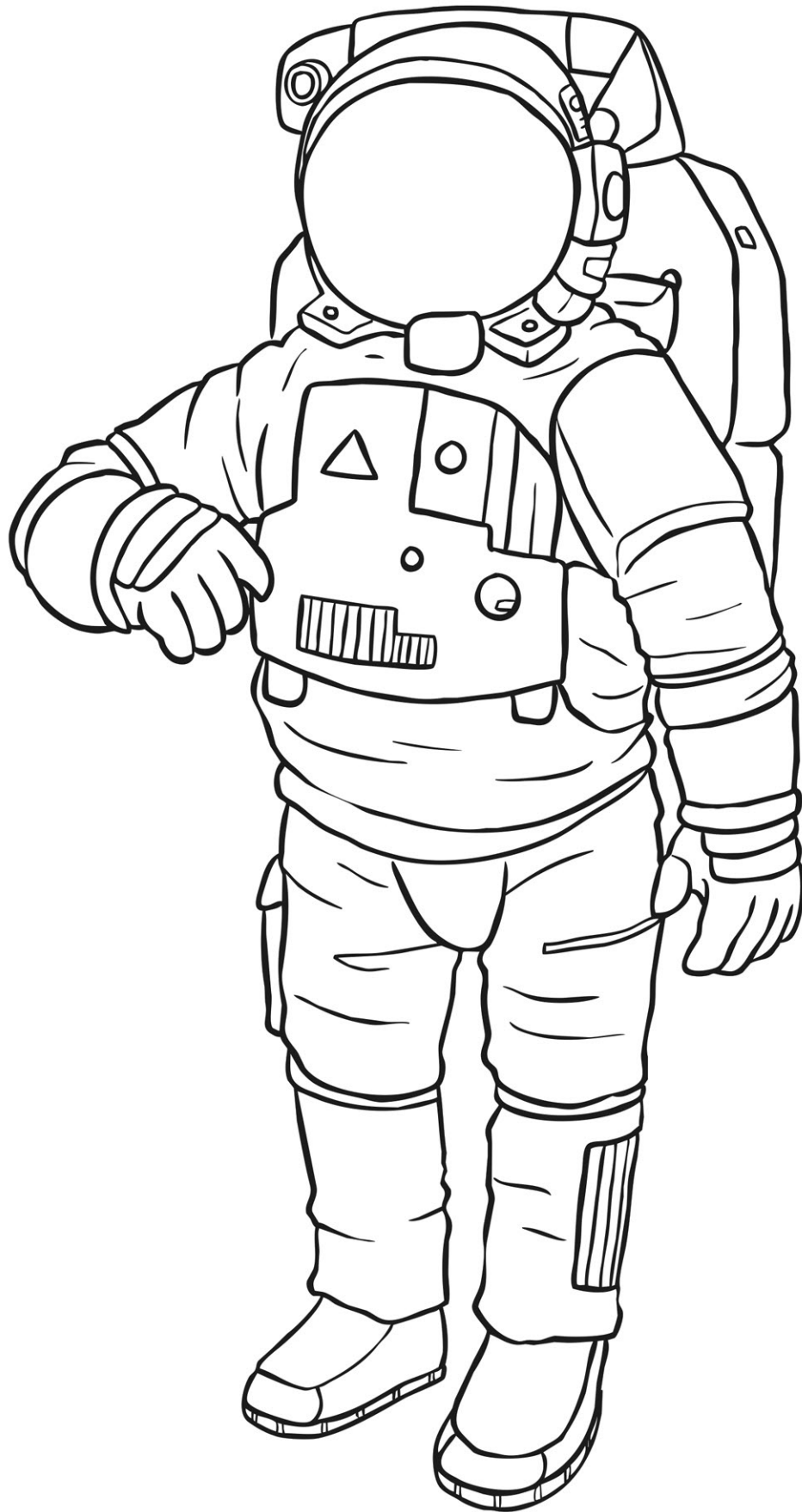

Robot

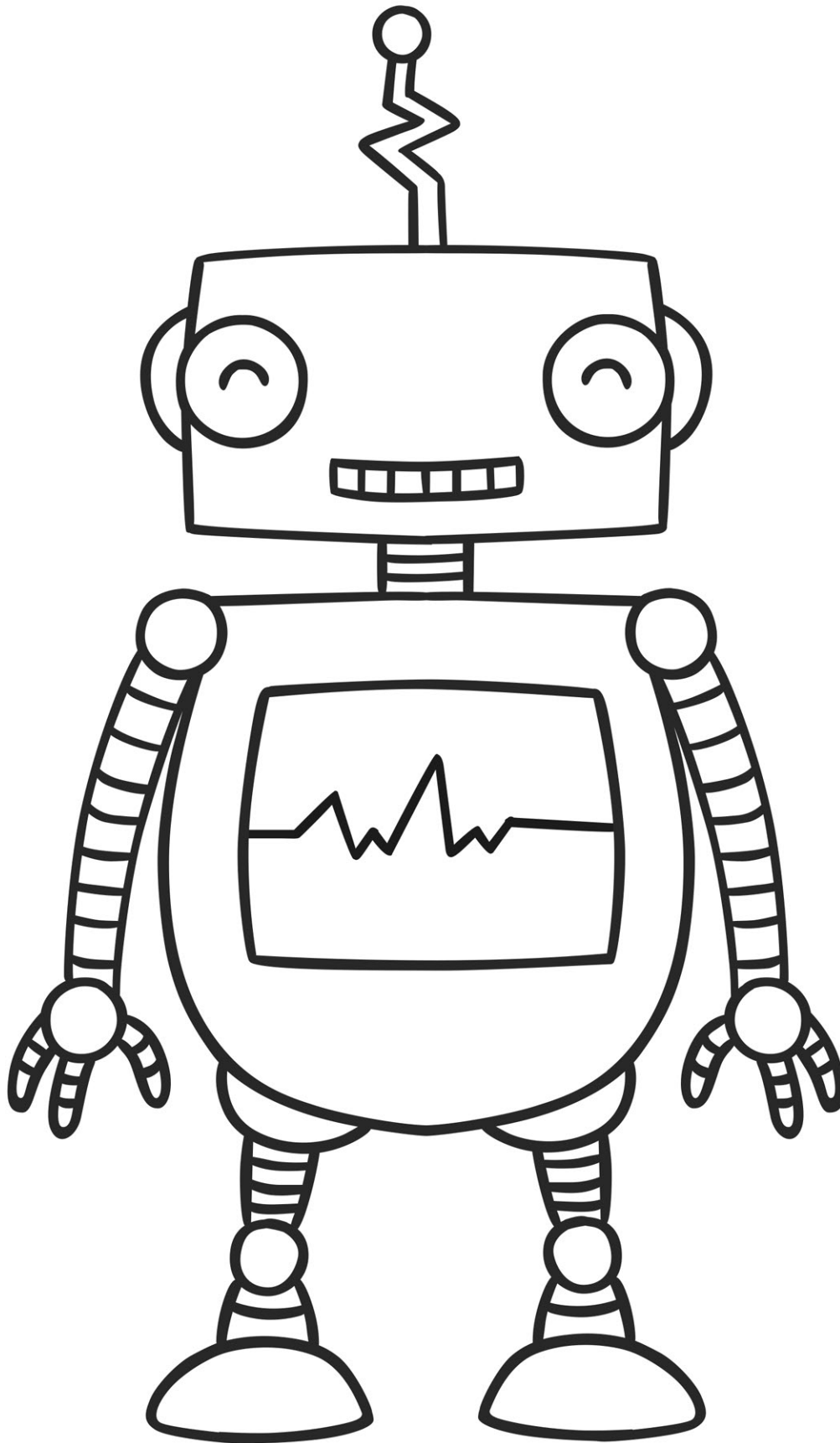

Rocket

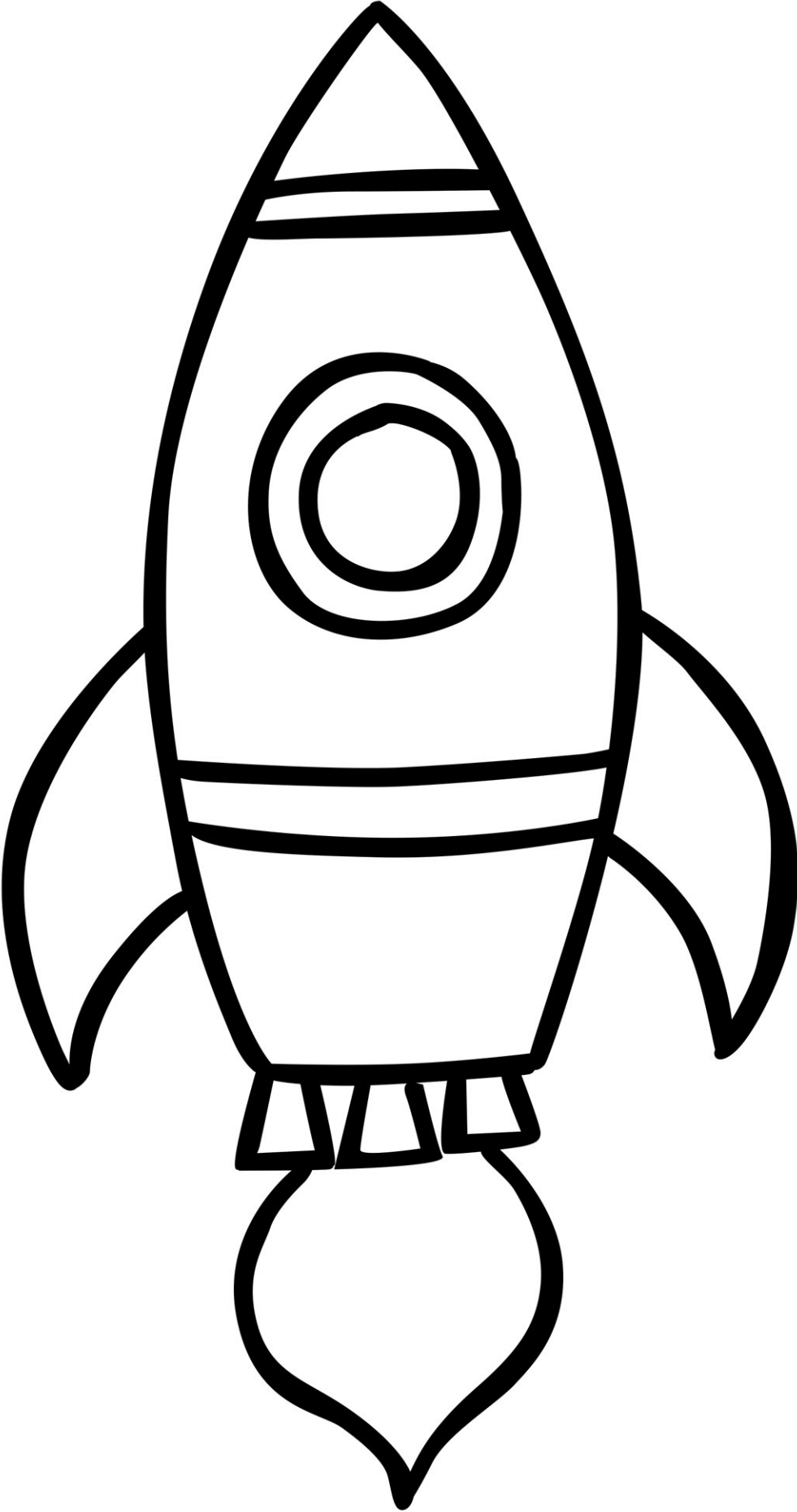

Space Shuttle

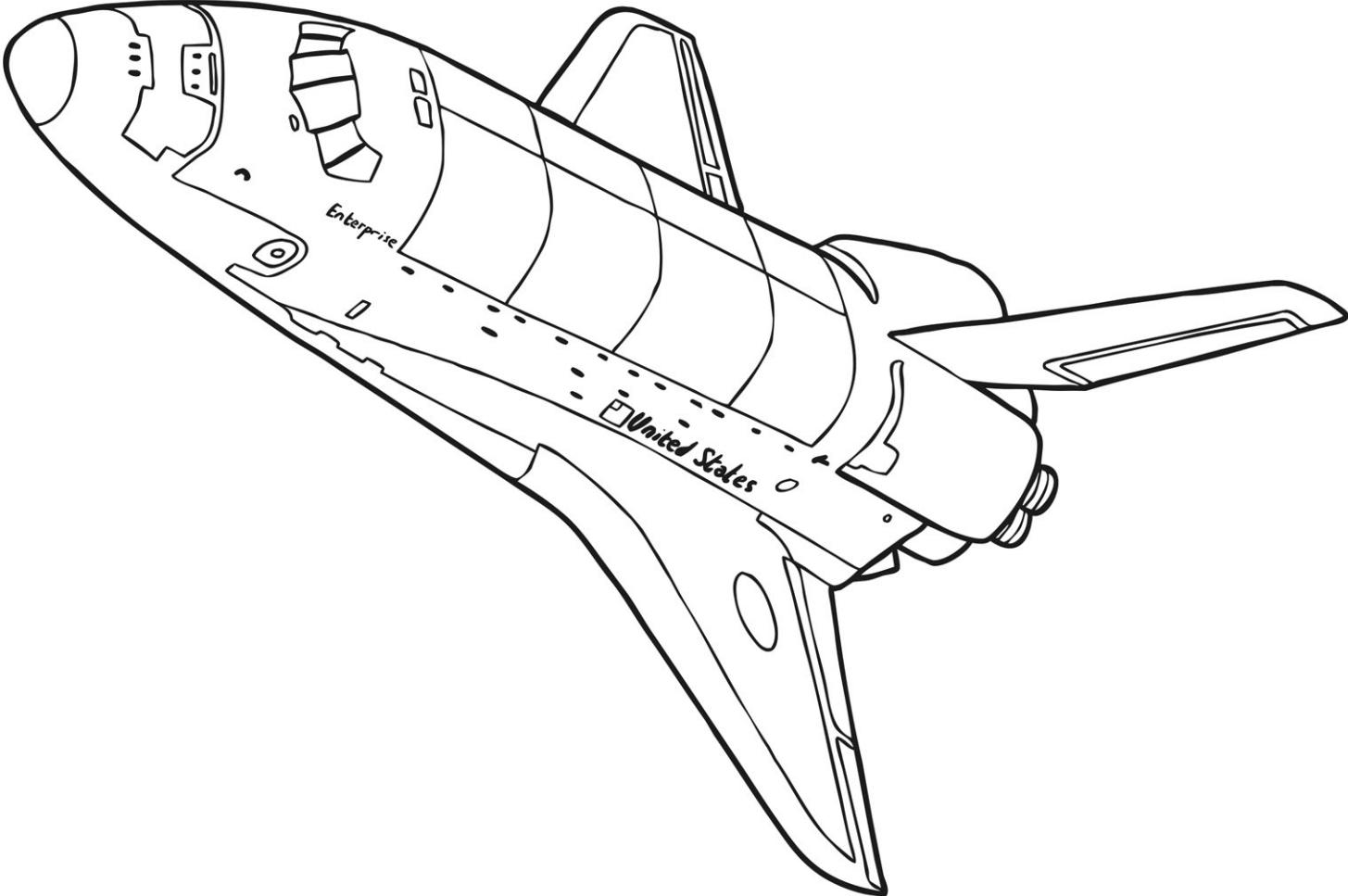

Satellite

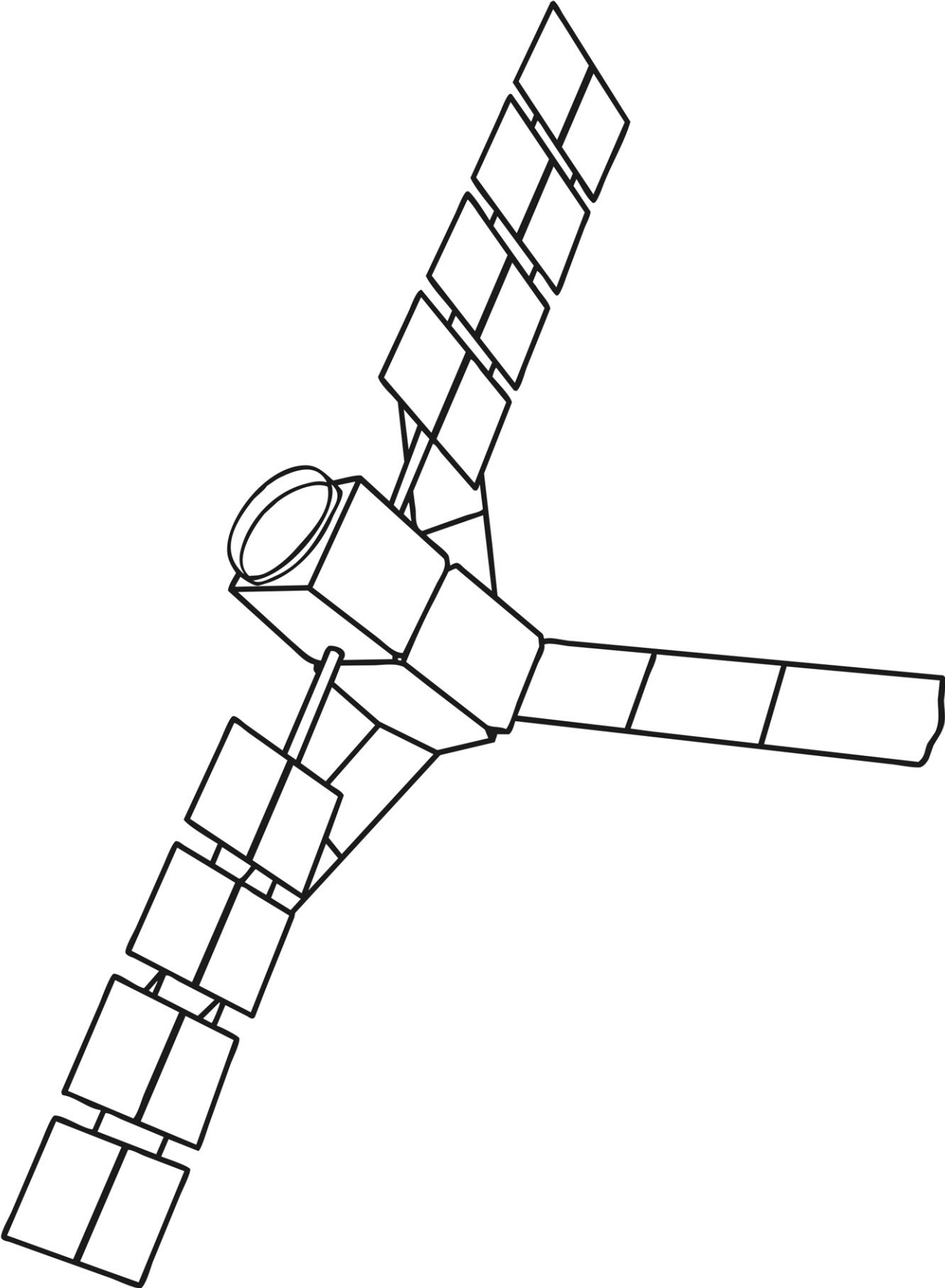

Planet

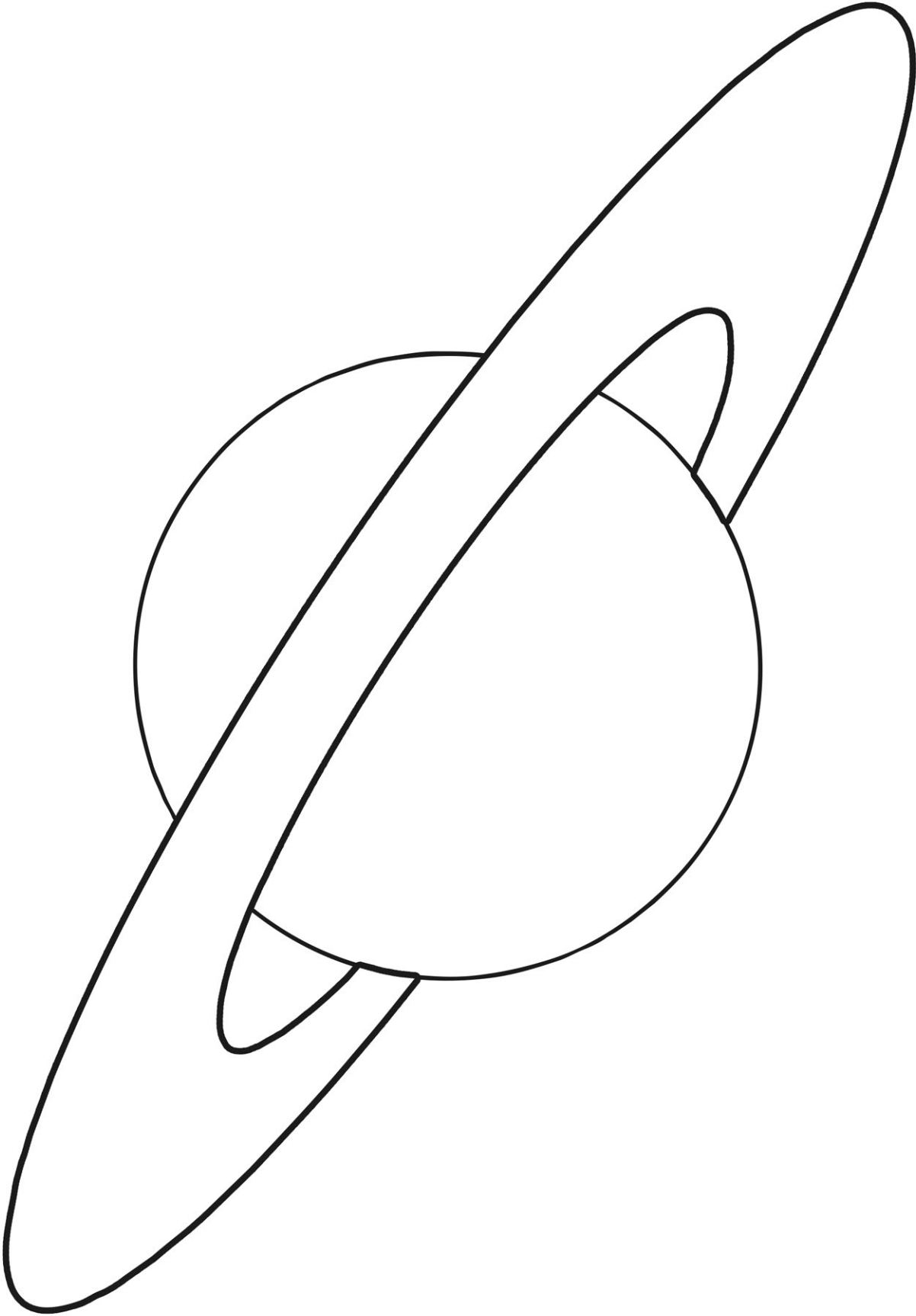

Asteroids

